

Miss Starstruck Fliar Phil's Bendix racer

Designed by Ray Malmstrom

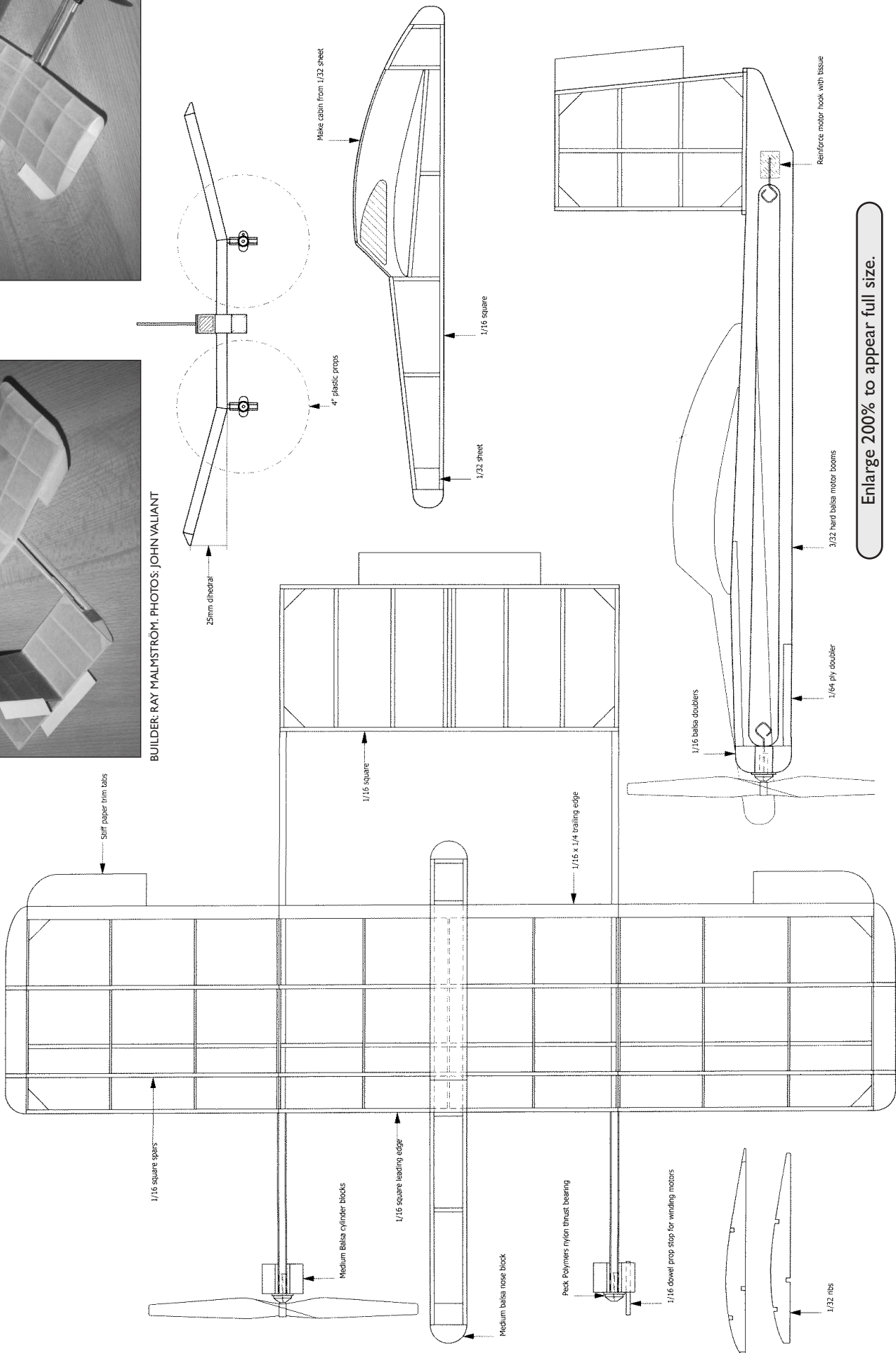
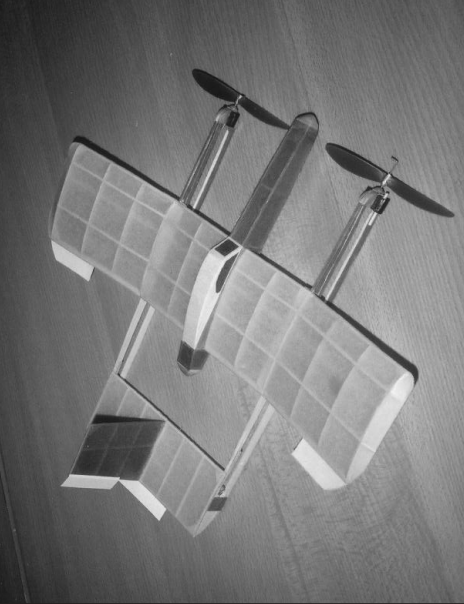
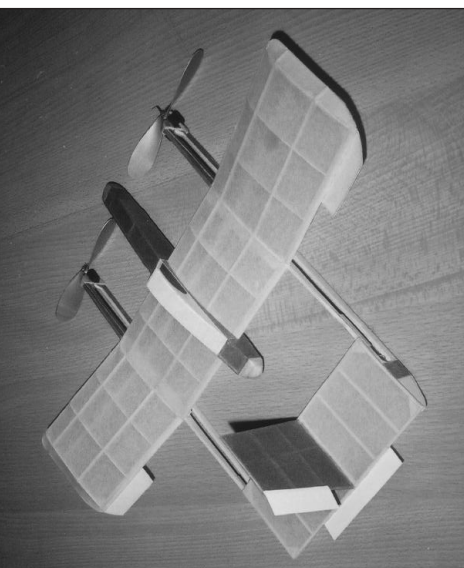

BUILDER: RAY MALMSTRÖM. PHOTOS: JOHN VALIANT

Enlarge 200% to appear full size.

Your FULL-SIZE Plan of the Month

A 22 inch control-line stunter for the novice modeller to suit a range of engines. .8-1cc

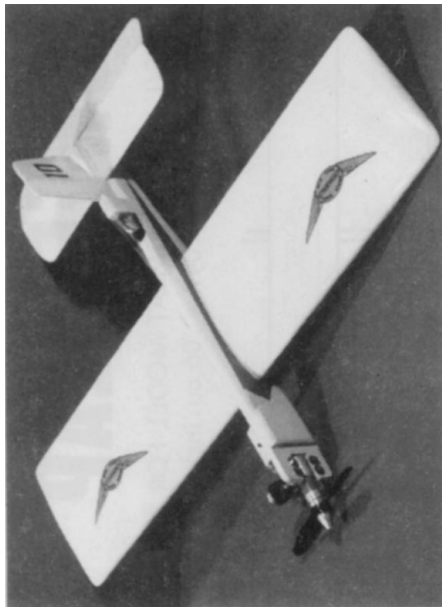

SWEETHEAP

by Ray Malmstrom

OUR MUCH-RESPECTED EDITOR, sent us by his most reliable (rubber-powered) carrier pigeon a demand, "Get going on a stunt-combat job for the .049-1 c.c. diesel or glow engines — and make it the best!" We heard, marked, and inwardly trembling got to work! 'Sweetheap' was the result. We think you'll go for this bundle of action.

Designer Ray Malmstrom (left) and Test-pilot Ken Radford (right) of the Impington College M.A.C. in happy mood after Sweetheap's highly successful maiden flight.

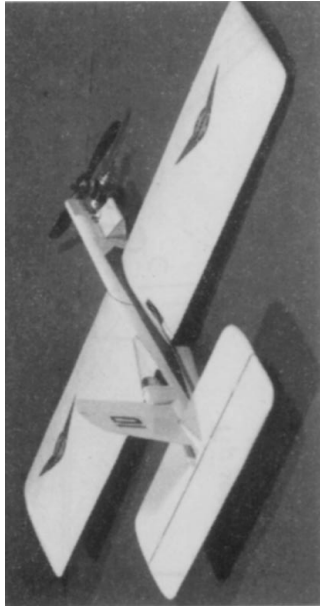
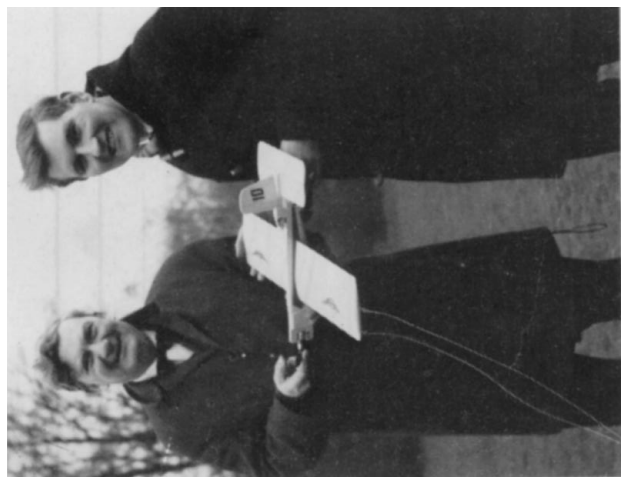

Take care with this important part of the wing construction (Fig. 5) Add the other balsa ribs (W2) noting that all port ribs have cut-outs to accommodate the lead-out wires. As you slot ribs W2 on to the lower mainspar you can check that they are correctly positioned by using jigs V and W in the same way as you used, jigs X and Y. Add upper mainspar and finally leading and trailing edges. Wing tips are cut from lengths of medium 1 in. sq. block, carved and sanded to shape, the port tip being drilled and bushed with brass tubing for the lead-out wires. These should now be installed (cut over-length) through the tubes and ribs and connected to the bellcrank. (Fig. 6). With bellcrank in the neutral position, cut the other ends of the lead-out wires off level, and form hooks. Cement $\frac{1}{4}$ in. sq. lengths of balsa between centre ribs (W1) reinforcing the leading and trailing edges (Fig. 7). Finally cover the top and bottom of the centre-section with $\frac{1}{16}$ in. sheet noting cut-out in the top sheeting to allow free movement of the control-rod. Lightly sandpaper the entire wing and cover with Modelspan tissue. Water shrink and give one coat of clear dope. The wing can be pinned to the building board supported on leading and trailing edge jigs V and W as shown in the small sketch on the plan. This keeps the wing true and prevents warps (most important) while firstly water and then the dope dries.

Assembly of wing to fuselage

The wing can now be installed pushing through the wing cut out in the fuselage. When in position and at right angles to the fuselage it can be firmly cemented. Add about $\frac{1}{4}$ oz. weight to the *starboard* tip. Now cement the tailplane $\frac{1}{16}$ ply control horn into its slot in the elevator

Slender profile is misleading, this 'Sweetheap' is tough though simple, flies through most manoeuvres like its bigger brothers. Original has a Cox .049.

and connect up to the control rod. Check that when the lead-out wire hooks are level the elevator, is at neutral (flat). You can adjust this before the cement holding the control horn sets. Then cement $\frac{1}{4}$ sq. pieces either side of the control horn as reinforcement, and cover the top surface of the tailplane, where the control horn slot was cut, with a small piece of linen or nylon tape. Solder a small washer to the end of the control-rod after it has passed through the control-horn to retain the control rod in position. Atraldite a Mercury commercial stunt tank in position as shown.

Decoration

Go over the whole model carefully with a fine grade sandpaper and eliminate the 'bumps' before application of your final finish. You can now paint your 'SWEETHEAP' and decorate it to your own scheme. If you use Humbrol enamel paint you need not (for all normal fuels) fuel-proof your model. Any transfers you may use, must of course, be protected by fuel-proofer. Bolt your engine to the engine mount, noting the $\frac{1}{16}$ thick washer, which gives the engine the necessary offset. See top view on plan. This offset will help to get you out of trouble if those lines ever go slack, so be sure you incorporate it as a safety factor!

Ready for flight

Connect the engine to the Mercury tank with a length of neoprene fuel-tubing and your SWEETHEAP is complete. It should balance on the FRONT lead out wire. You may need a small amount of nose or tail weight to obtain correct balance depending on the weight of the engine you use. Fly on 30-35 ft. steel lines. Good luck — and be seeing you. — *inverted* of course!

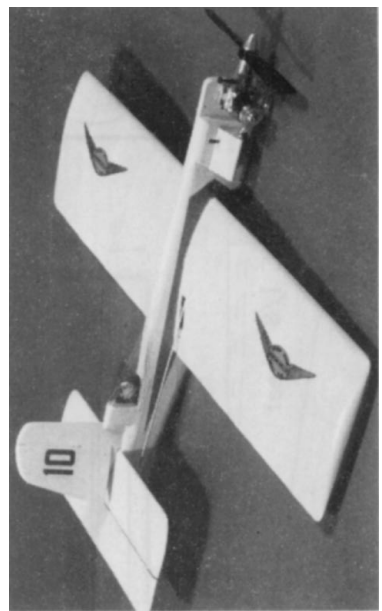

Ready for action! The Golden Wings Club transfers signify how suitable 'Sweetheap' is for the novice or junior modeller especially those wanting to learn how to do their first loop or to fly inverted.

Fuselage

This is simple and straightforward. Cut the basic shape from medium $\frac{1}{4}$ in. balsa sheet, carefully removing the wing cut-out and the cut-out at the rear of the fuselage. Cut notches for receiving the fin and engine mount. Make engine mount from $\frac{1}{4}$ in. ply and drill for the engine you intend to use. Cement this into the cut out at front of fuselage. Cement filling pieces A in place and finally $\frac{1}{16}$ in. ply pieces B. (See fuselage construction sketch). Cover cockpit with thin acetate sheet, installing a 'profile' pilot, if desired. Add $\frac{1}{4}$ in. piece C, and the $\frac{1}{16}$ ply skid. Carefully sandpaper fuselage to section shown. Cover the rear cut-out area with tissue and water shrink. Construct tailplane making sure the elevator moves freely on its linen or tape hinges. Do not install the control-horn at this stage. Give tailplane two coats clear dope. Cement to fuselage, checking that fin slot on tailplane and fin slot cut in rear of fuselage coincide. Cut fin from $\frac{1}{4}$ in. sheet, and carefully off set rear portion as shown. Dope as for tailplane. Cement fin firmly in place, the lower front edge fitting into the slot already cut at the rear of the cockpit fairing and the tab into the slots cut in the tailplane and fuselage. Give the completed fuselage two coats of clear dope, sanding lightly between each coat.

Cut bellcrank from $\frac{1}{16}$ ply (or use a commercial bellcrank of the same size). Connect the control rod to the bellcrank. Solder a small washer on the control rod as shown (Fig. 1). Cut the bellcrank mount from $\frac{1}{16}$ ply and assemble bellcrank and control rod to it, soldering the lower nut on to the pivot bolt as shown on plan (Fig. 2) Cut two ribs (W1) from $\frac{1}{16}$ ply and assemble bellcrank mount unit to these ribs. Check that the ribs are at right angles to the mount (Fig. 3). Add $\frac{1}{4}$ sq. blocks (Fig. 4). Now pin the lower $\frac{3}{8}$ in. x $\frac{1}{8}$ in. mainspar, that runs the whole span of the wing, over the plan. On to this spar is lowered the bellcrank — centre ribs assembly. Cement accurately in place. To keep the ribs correctly aligned you can use the jigs X and Y cut from $\frac{1}{4}$ sheet. Use modelling pins to hold everything in place while cement dries.

W2

SWEETHEAP

22" WING SPAN

C/L STUNT/COMBAT MODEL FOR BEAM-MOUNTED ENGINES
.8 cc - 1 cc (.049 - .06 cu. ins)

by **Ray Malmström**

W2

Tips 1" sq. block

Cut recess in tip block and install approx. 1/4 oz. wing tip weight (starboard tip important)

W2



1/8" sheet 2 off

Motor mount 1/4" ply
Drill to suit engine used

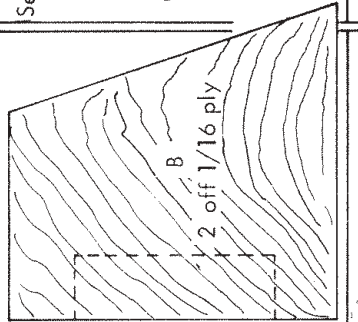

2 off 1/16 ply

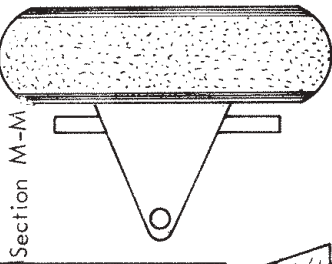

Section M-M

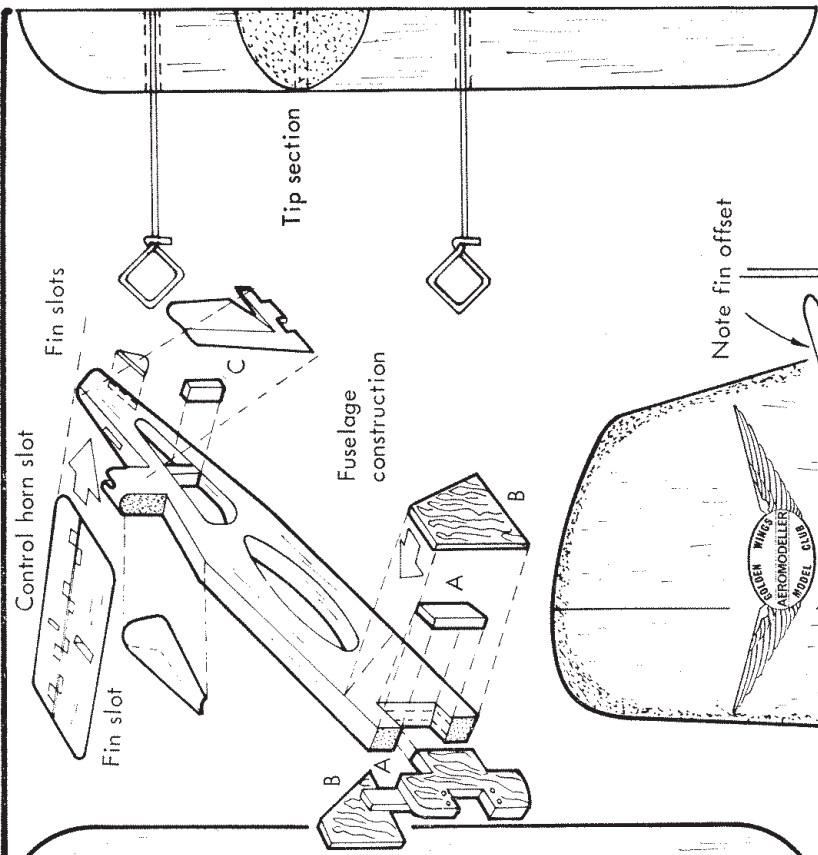

Tip section

Fuselage construction

Note fin offset

X

Ribs W1 1/16" ply

Thin acetate sheet

Profile pilot 1/8" sheet

Jigs 1/8 X, Y, V, W

Control rod 16 s.w.g.

Cut out and cover with tissue

C 1/8" sheet

Cut slot for fin tab

Note fuselage taper

Approx. 45° up and down movement

Fly on 30-35" steel lines

Fuselage 1/2" sheet

Fuselage shape in heavy outline

1/16 ply

Enlarge 125% to appear full size.

L.E. 1/4 x 3/8

W2 Washer soldered on



Fig. 1

STAGES OF WING CONSTRUCTION.



Fig. 2

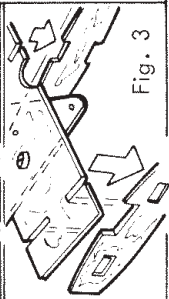

Fig. 3



Top and bottom main spars 3/8 x 1/8

Brass tubing

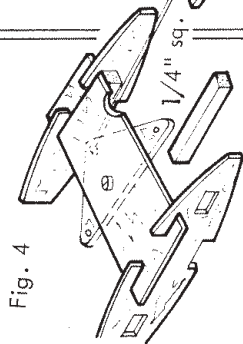

Fig. 4

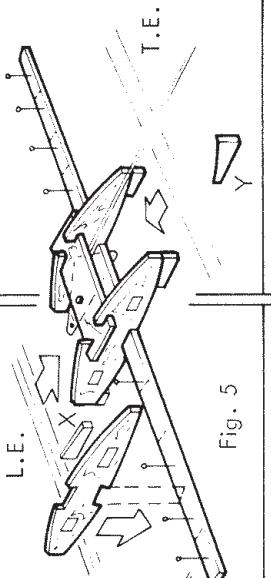

Fig. 5

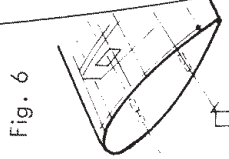

Fig. 6

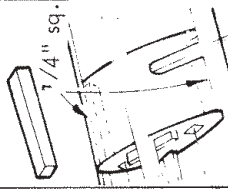
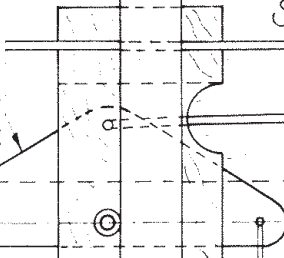

Fig. 7

Cover centre section top and bottom with 1/16 sheet. Note cut out for control rod.

All ribs W 2 1/16 sheet

Bellcrank 1/16 ply or commercial type



1/16" washer

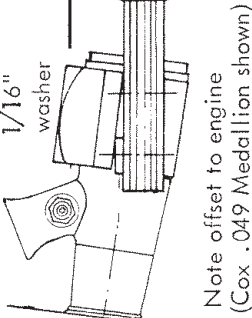

Note offset to engine (Cox .049 Medallion shown)

Join plan at "X" - "X" after removing from Magazine

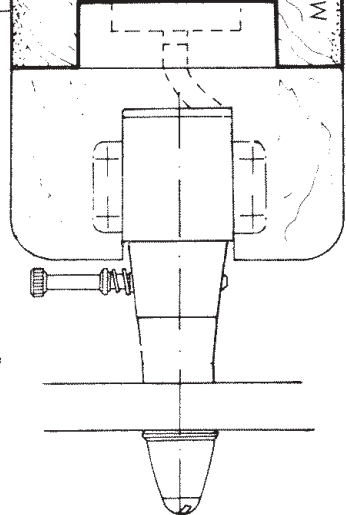

T.E. 5/8 x 5/16

Roy Malmstrom's SWEETHEAP sheet two

Fin 1/8 sheet

Fin slot



C/L



Control horn slot

1/8 sq.

Tape over control horn

Tape hinges (clothes horse system)

Tailplane 1/8" sheet

Sand edges to section

Tailplane 1/8" sheet

Bellcrank mount 1/16 ply

Dr II 3/32"

PRIMARY GLIDER

Enlarge 143% to appear full size.

